

Article number: 01010791
 Description: Retaining ring A 65 DIN 471
 Stainless 411
 Note: Fitted with ZGA pilers

Measures

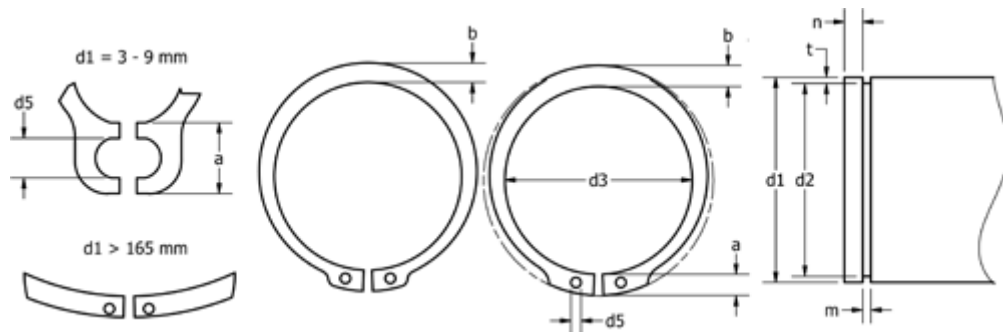

a max	= 7.8	FN kN	= 49.8	s	= 2.50
AN mm ²	= 299.0	FRg kN	= 22.70	t	= 1.50
b	= 6.3	FR kN	= 135.00	tol	= -0.30
d1	= 65	g	= 2.5	tol	= -0.07
d2	= 62.0	K kN-mm	= 245.00	tol	= +0,46-1,10
d3	= 60.8	m min	= 2.65	Tong	= ZGA-3
d5 min	= 3.0	n abl x 1000	= 7.0	Weight kg/1000	= 18.200
Description	= A65	Nominal drive	= 4.5		